

0

AQUA MEDIC

Montageanleitung

Armatus 500 XD

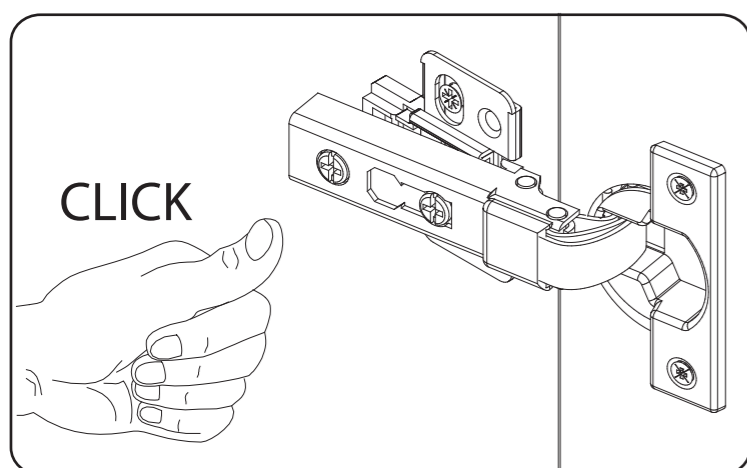
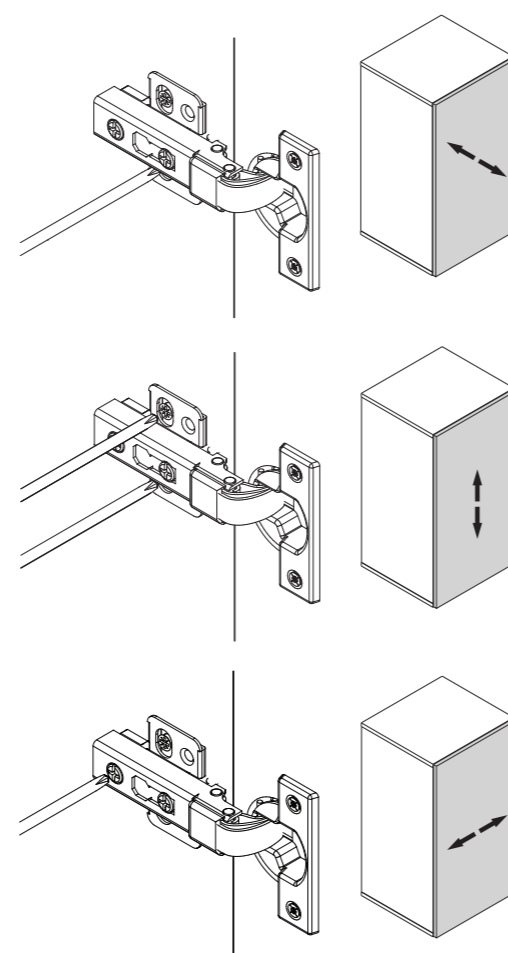
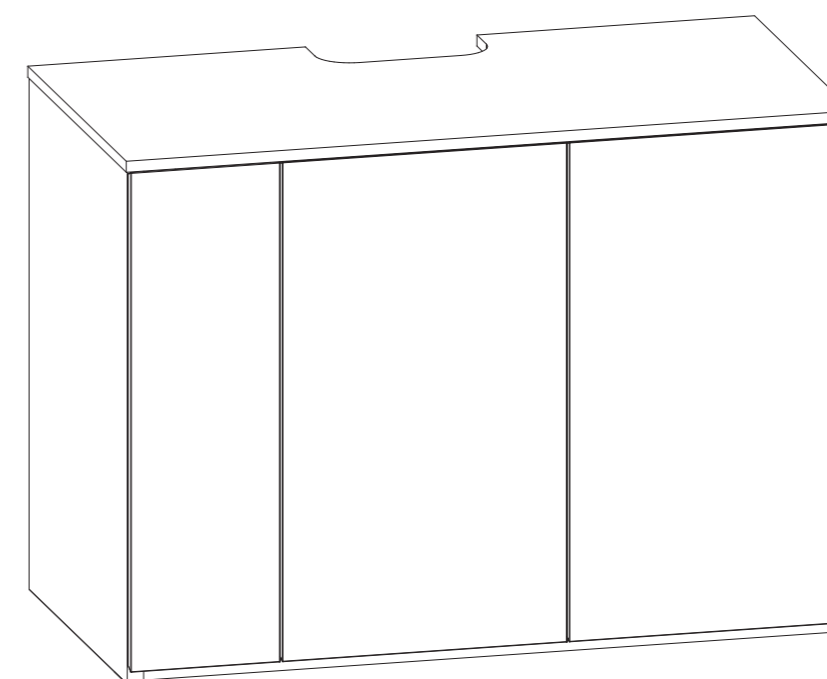
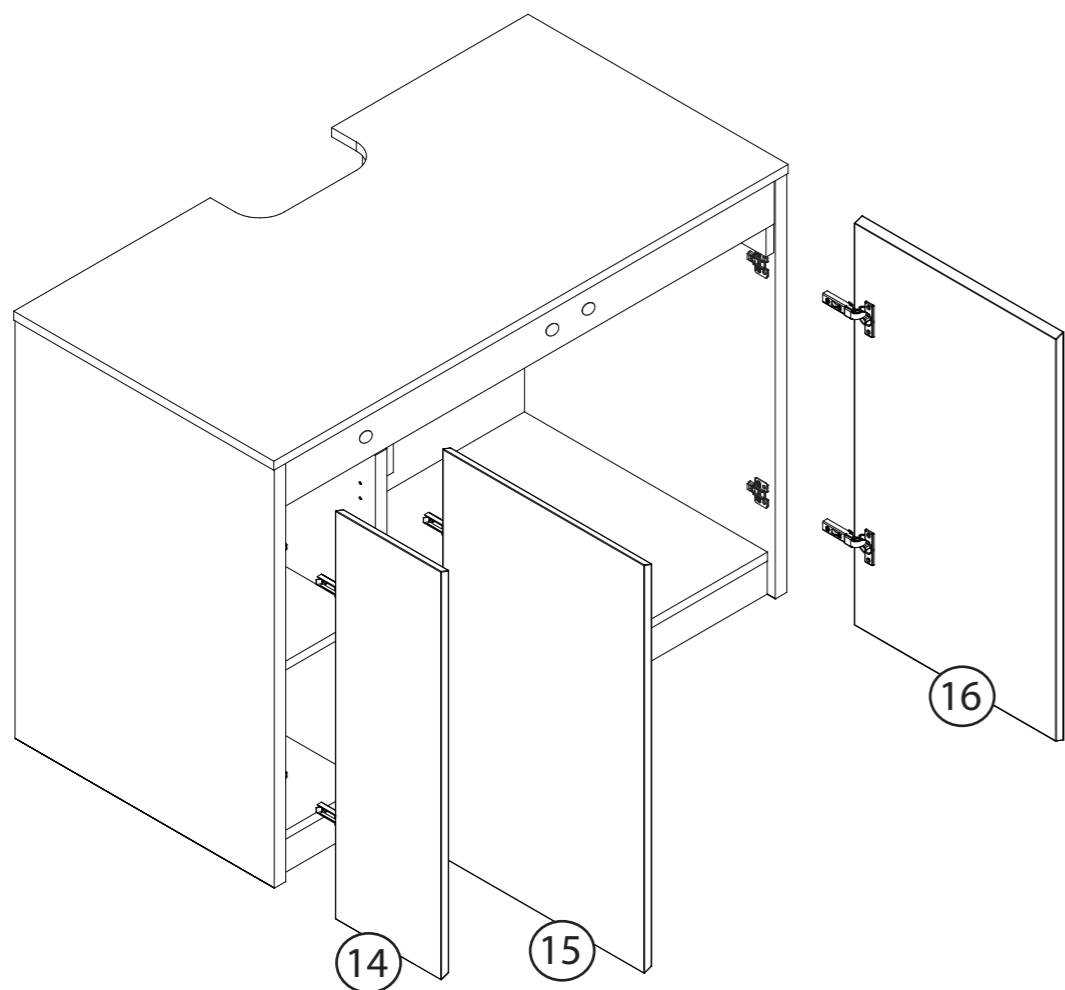

AB Aqua Medic GmbH
Gewerbepark 24
49143 Bissendorf, GERMANY

Fon: +49 5402 9911-0
Fax: +49 5402 9911-19

www.aqua-medic.de
info@aqua-medic.de



N

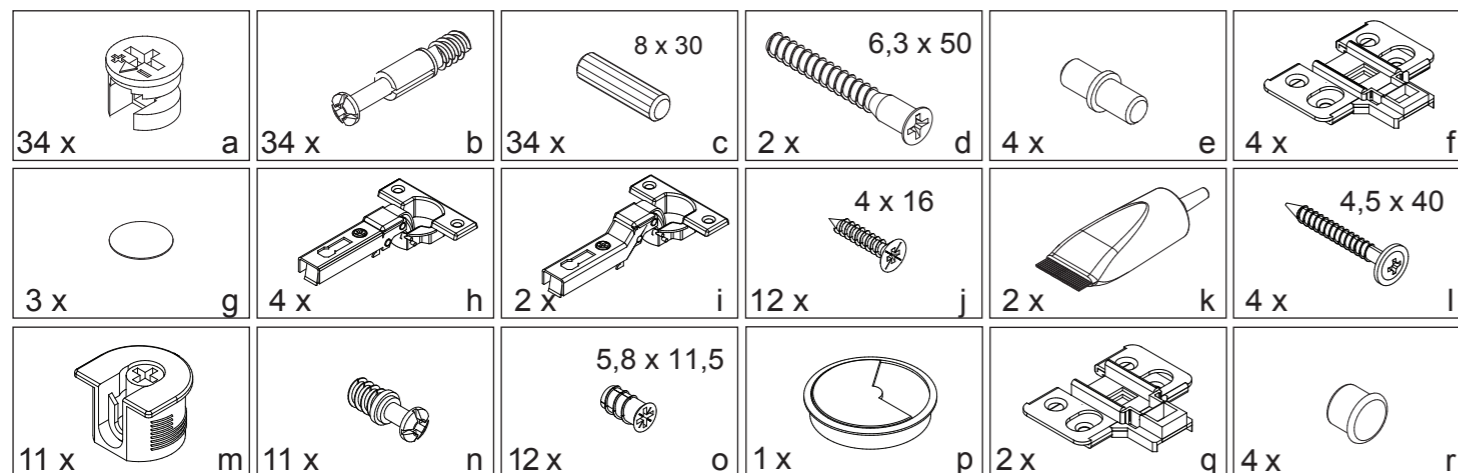
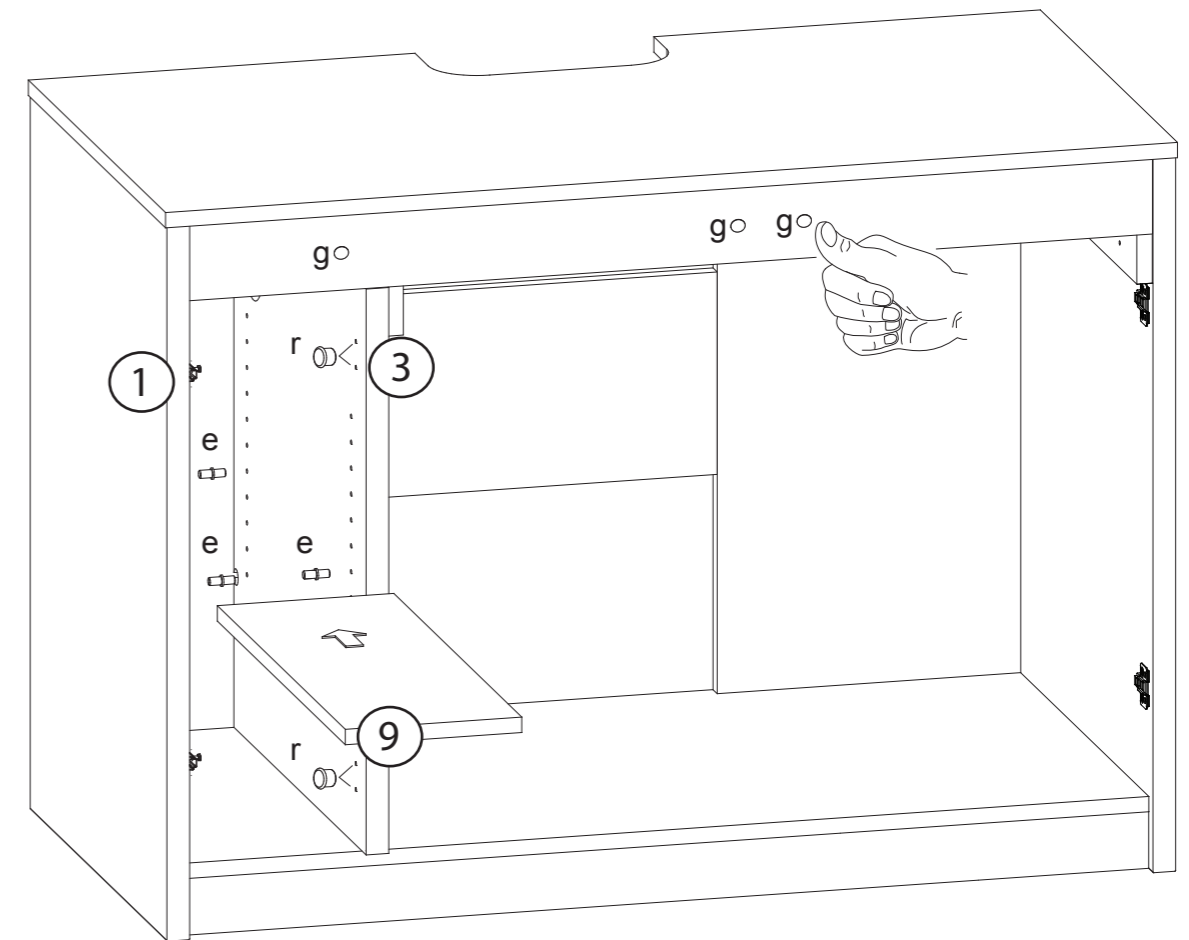
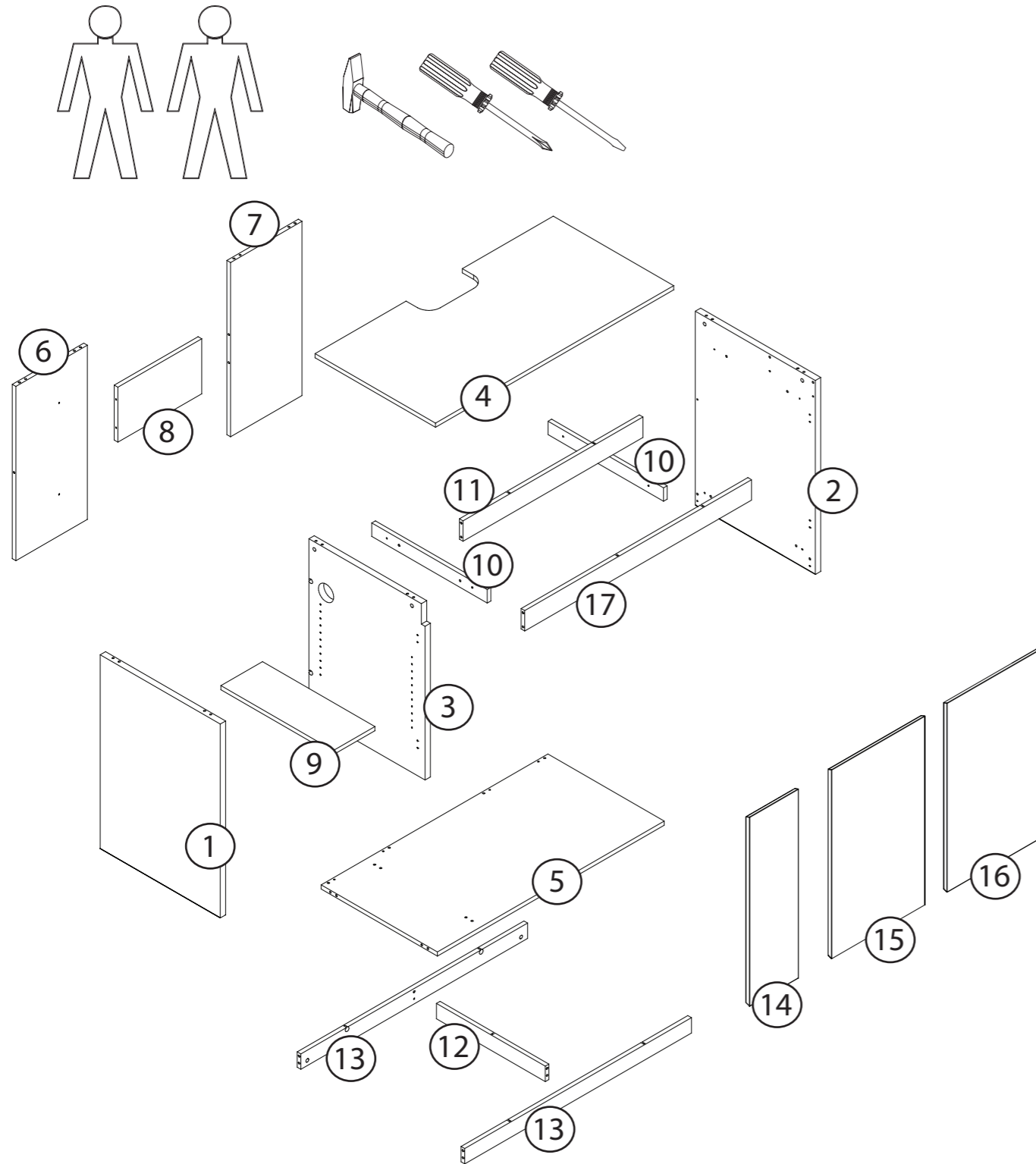
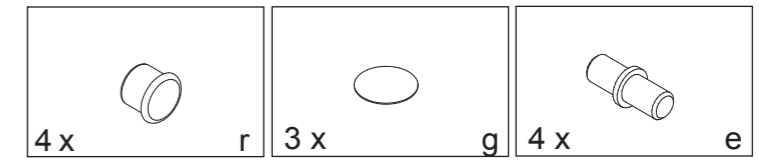

L

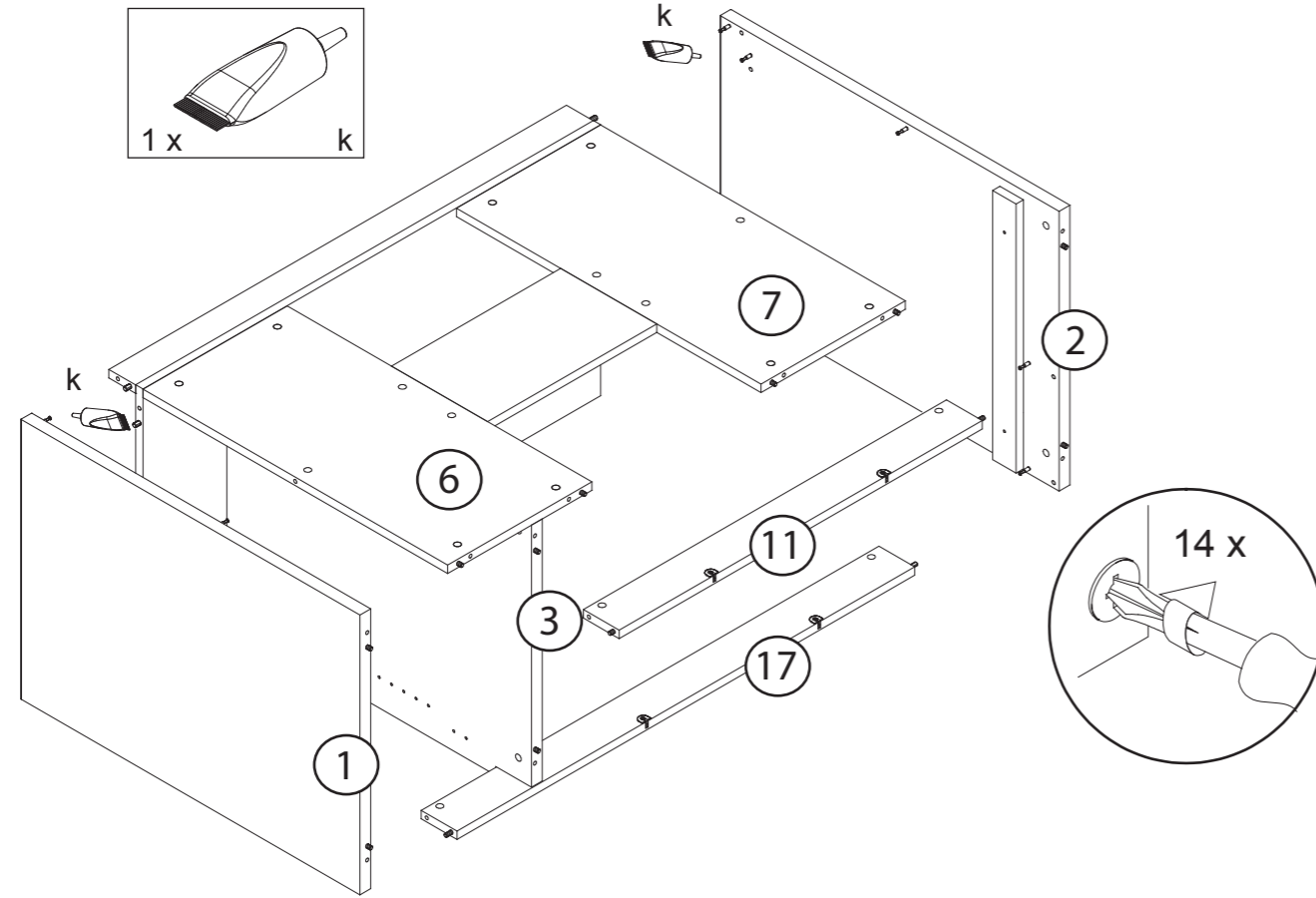

M

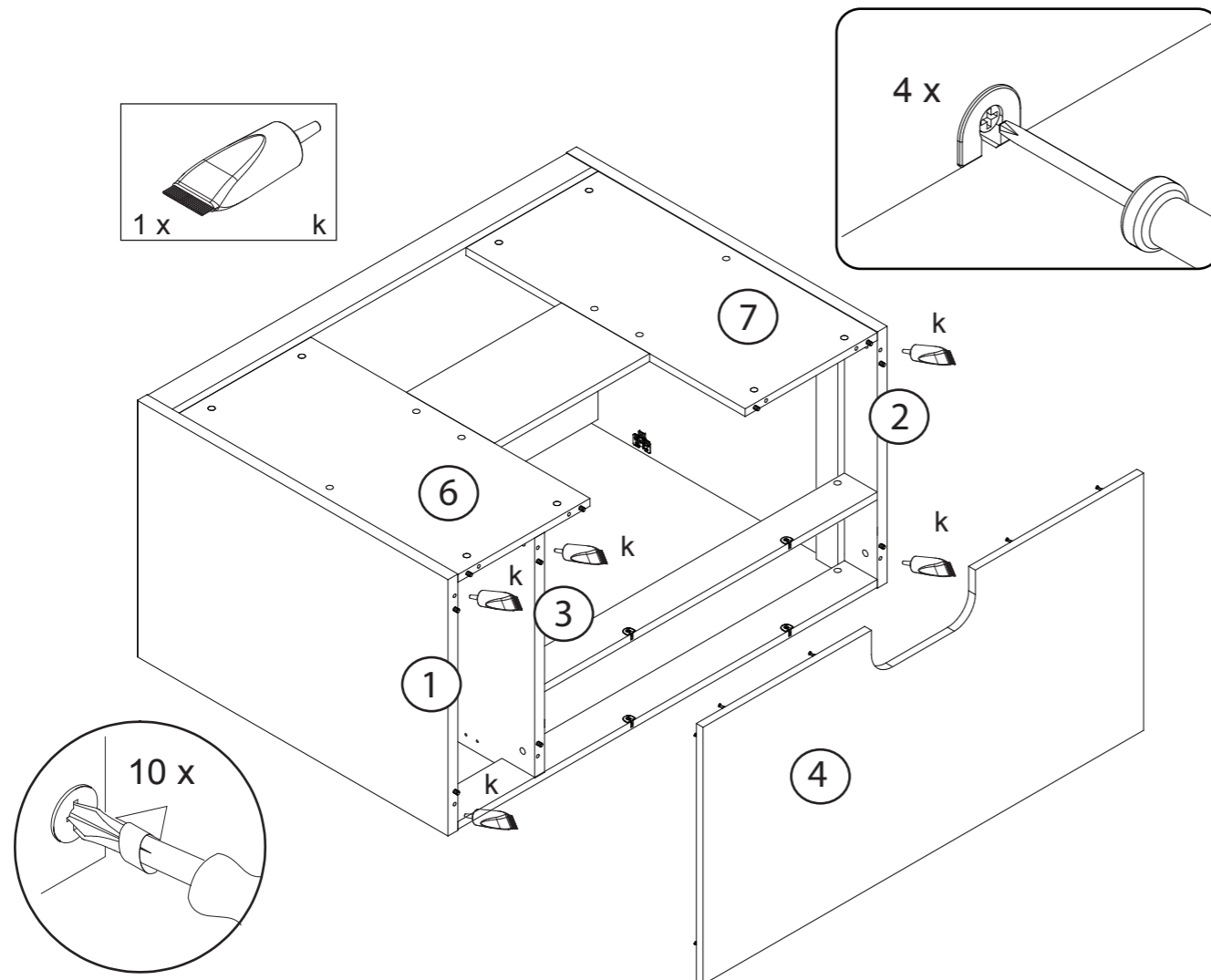

A

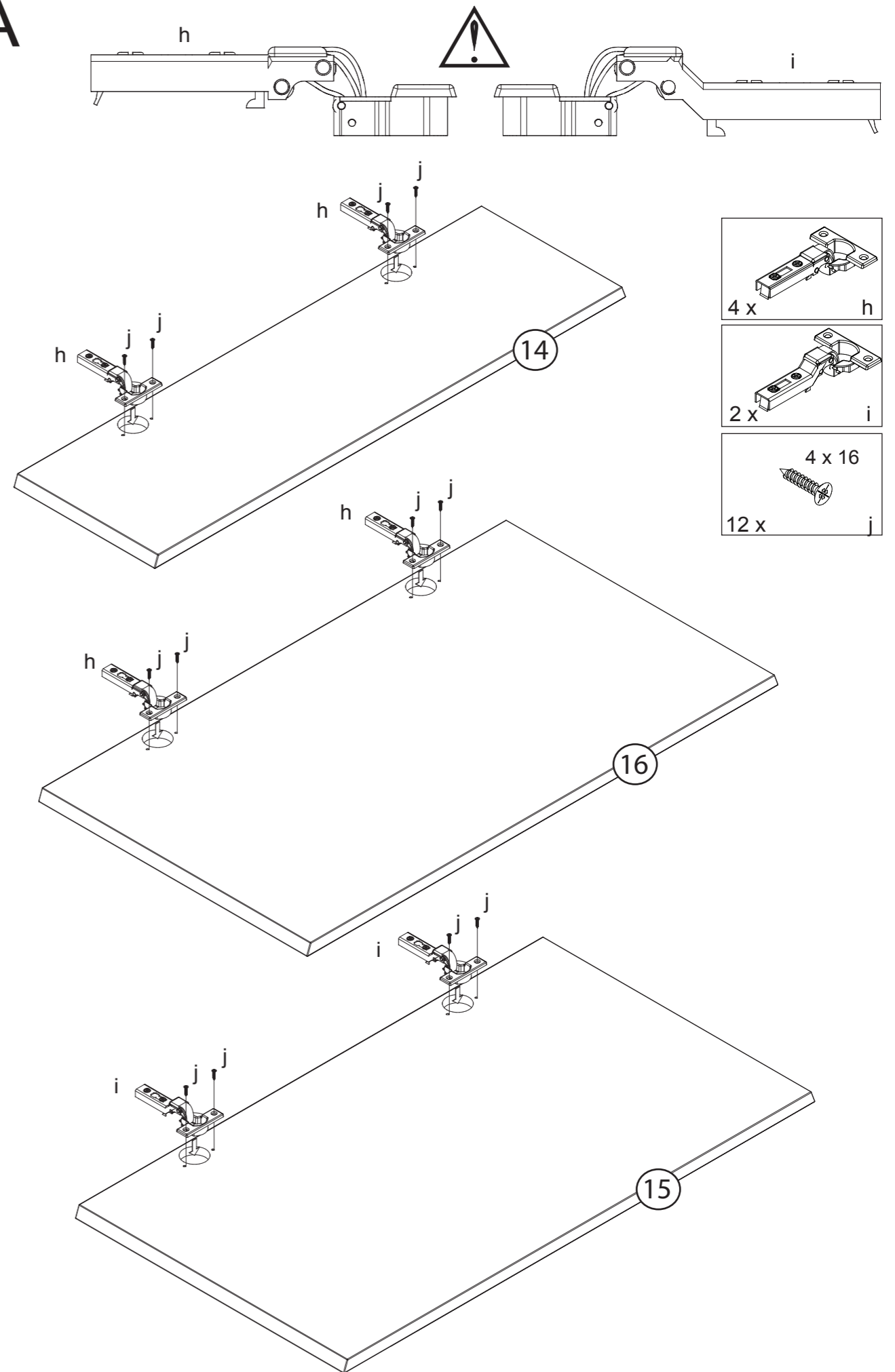

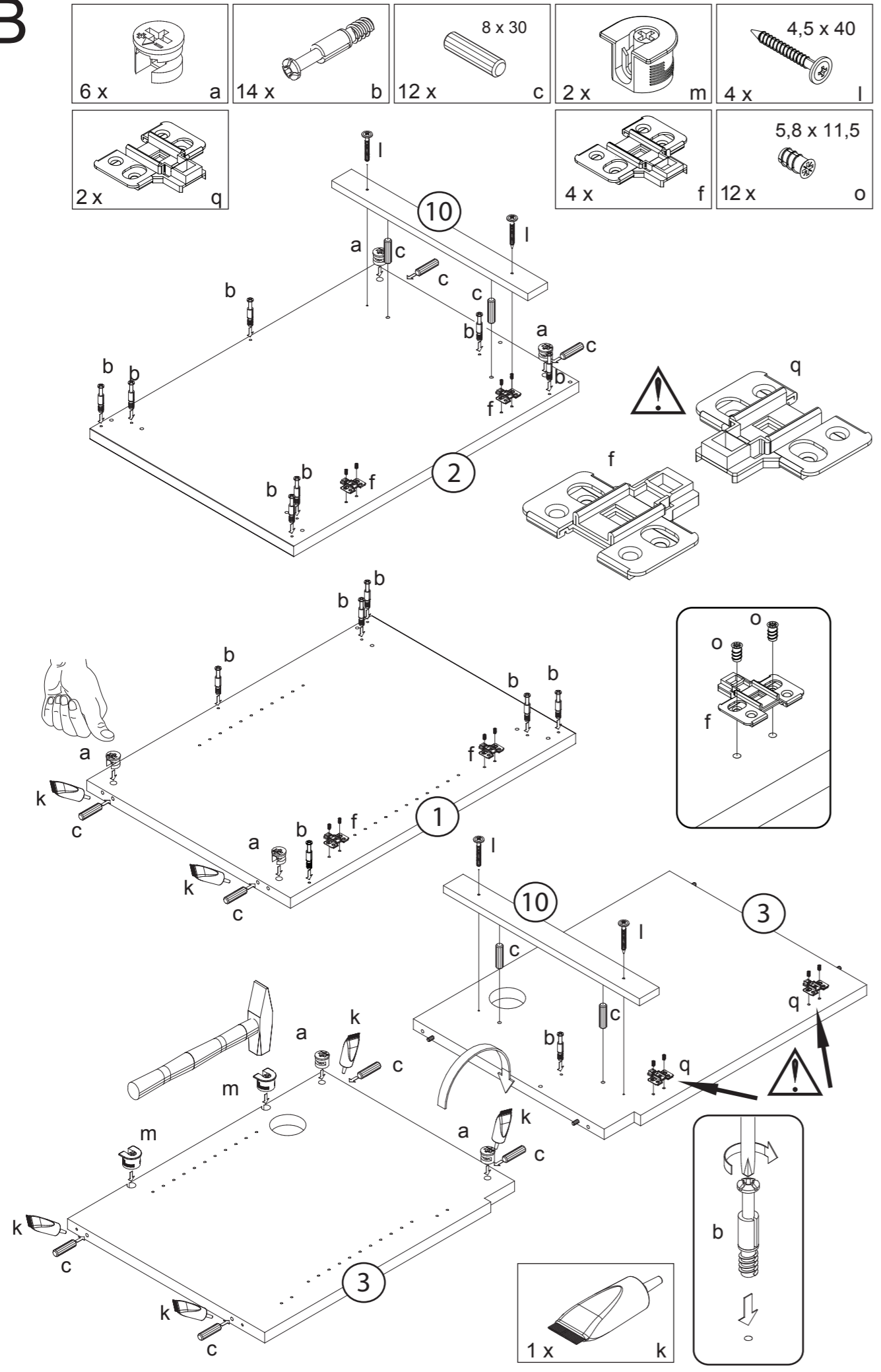
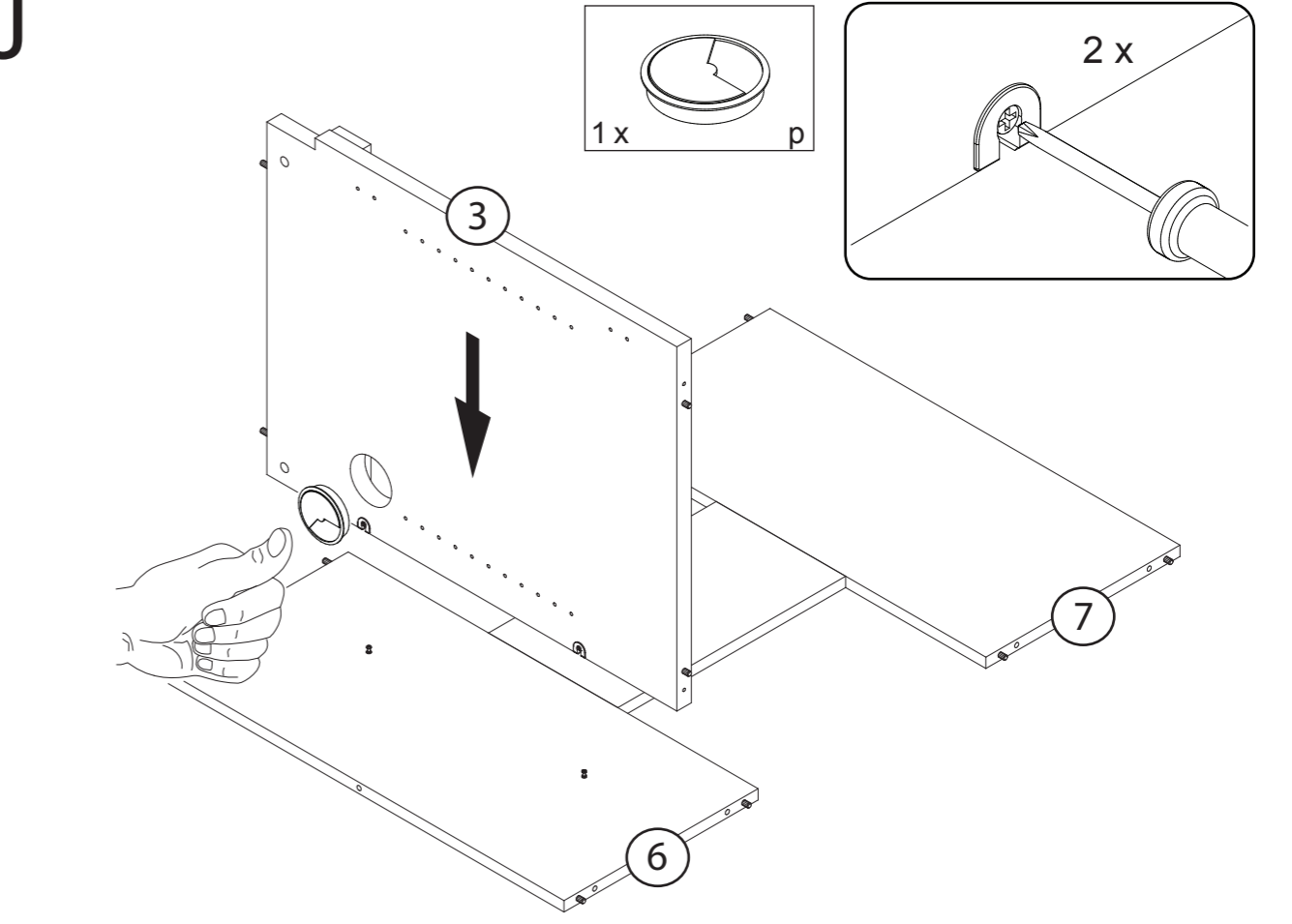
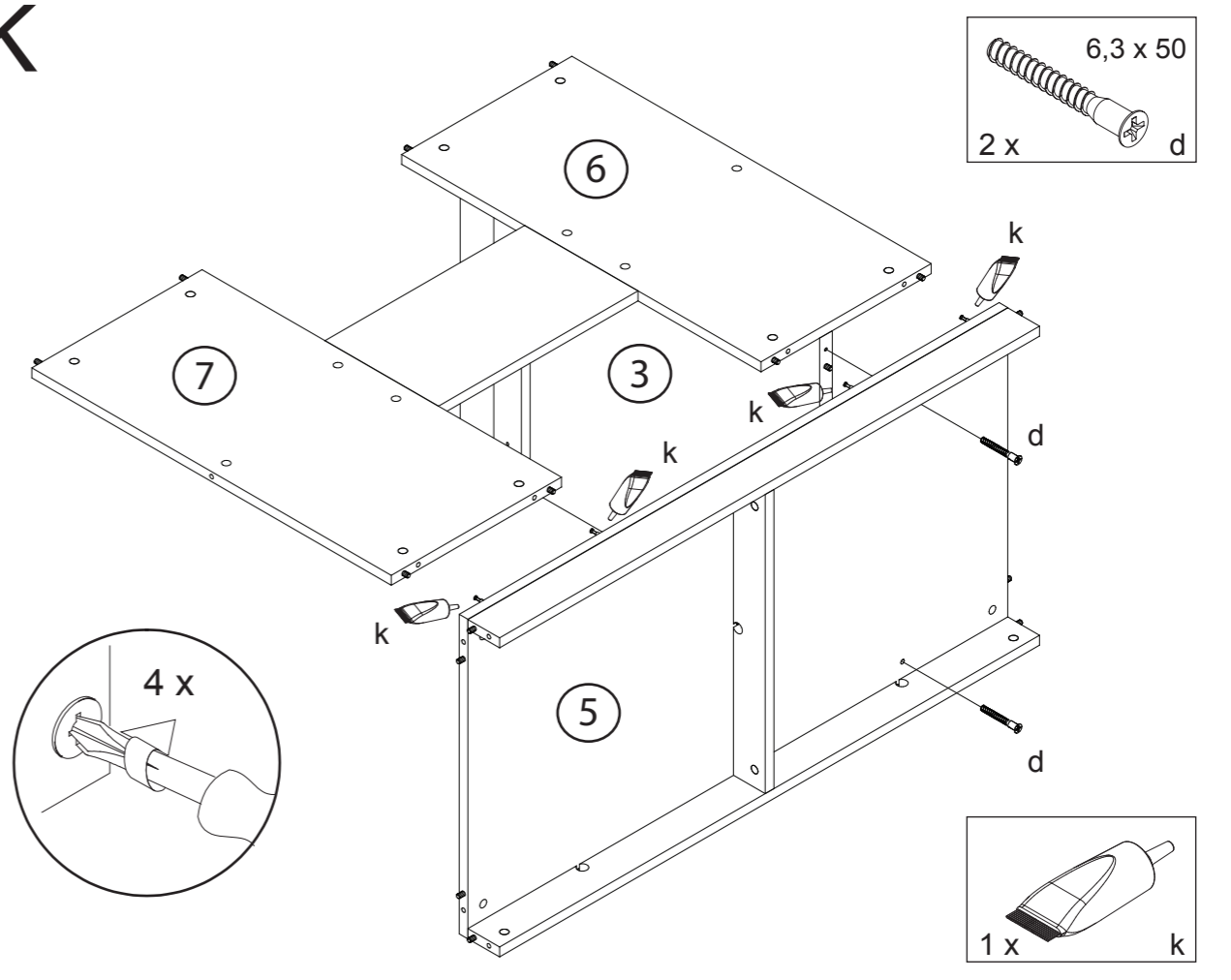
B**J****K**

H

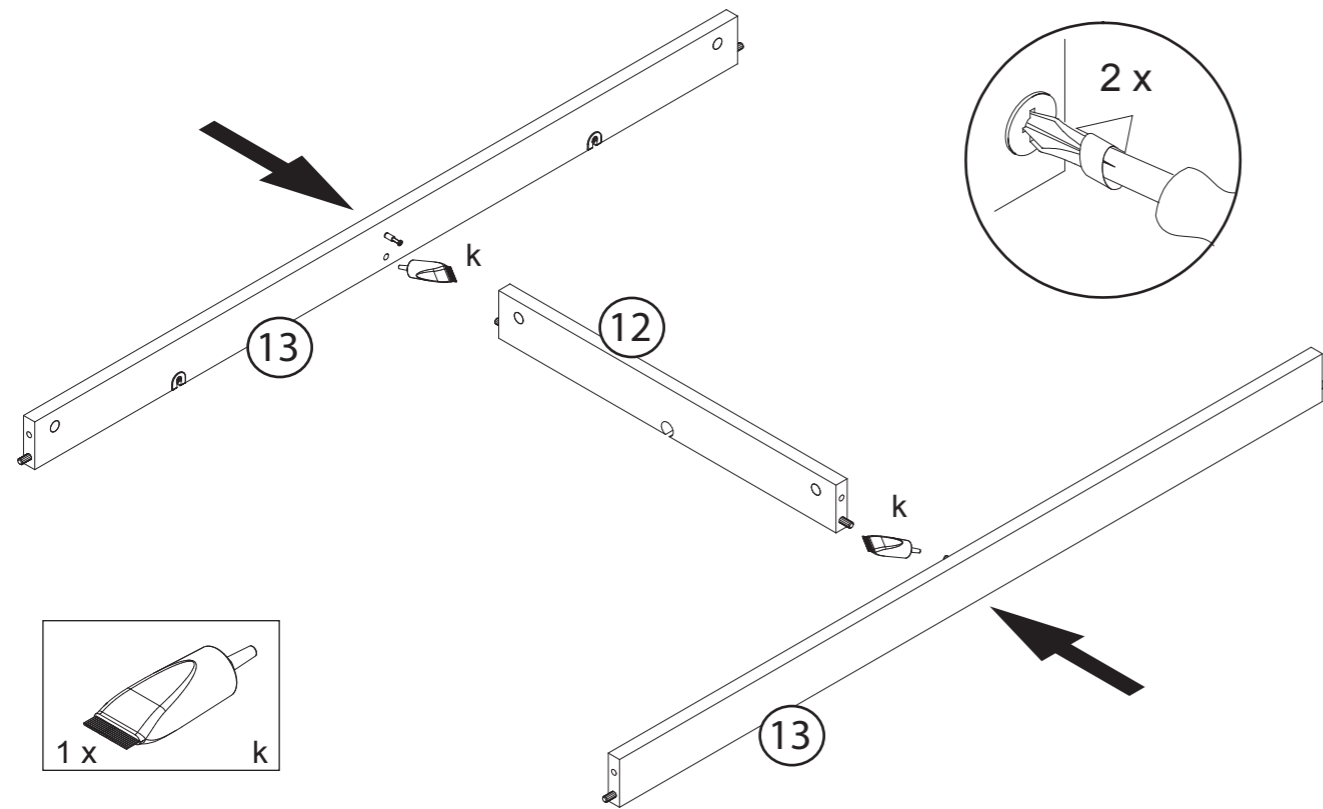

I

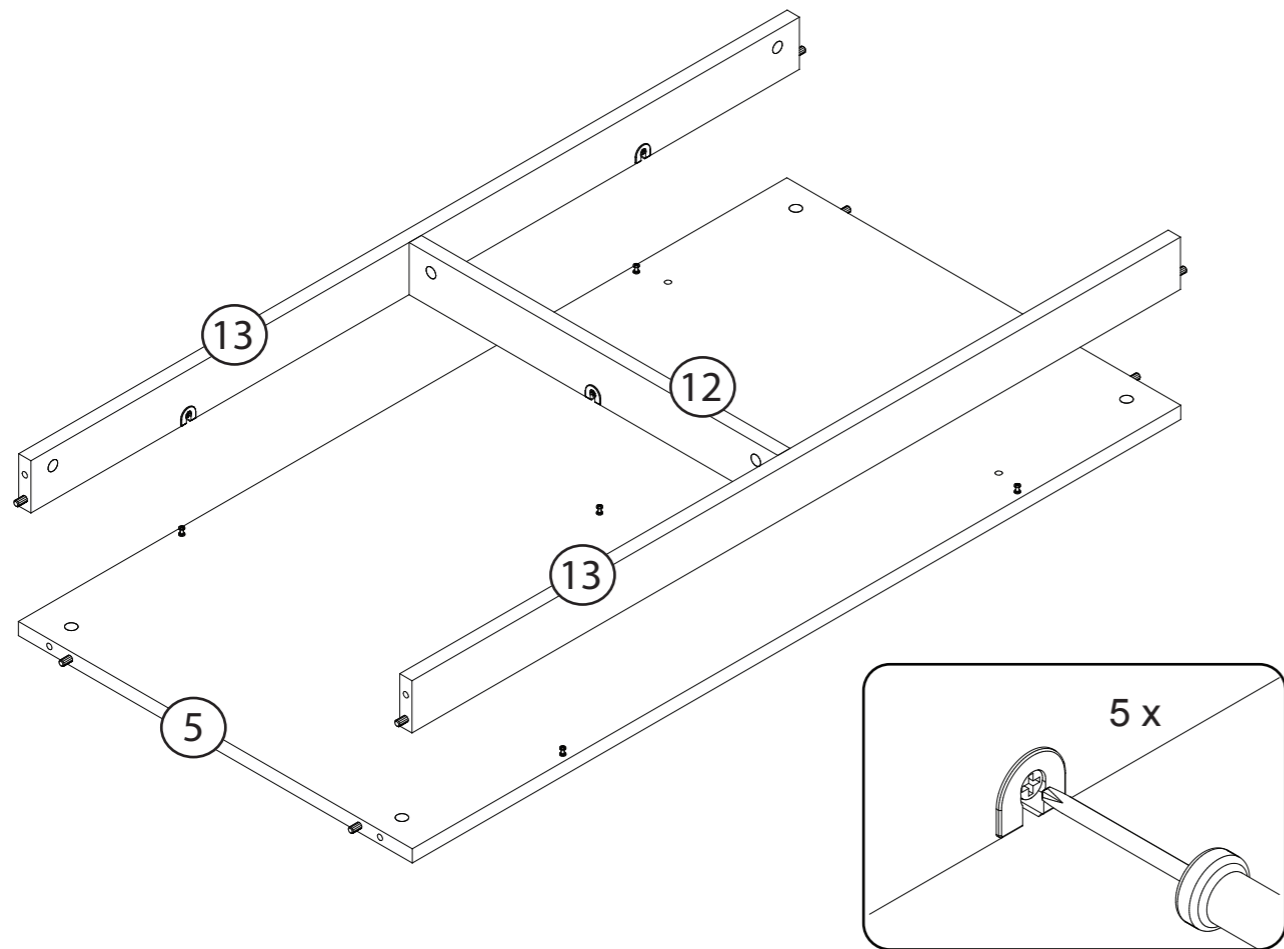

C

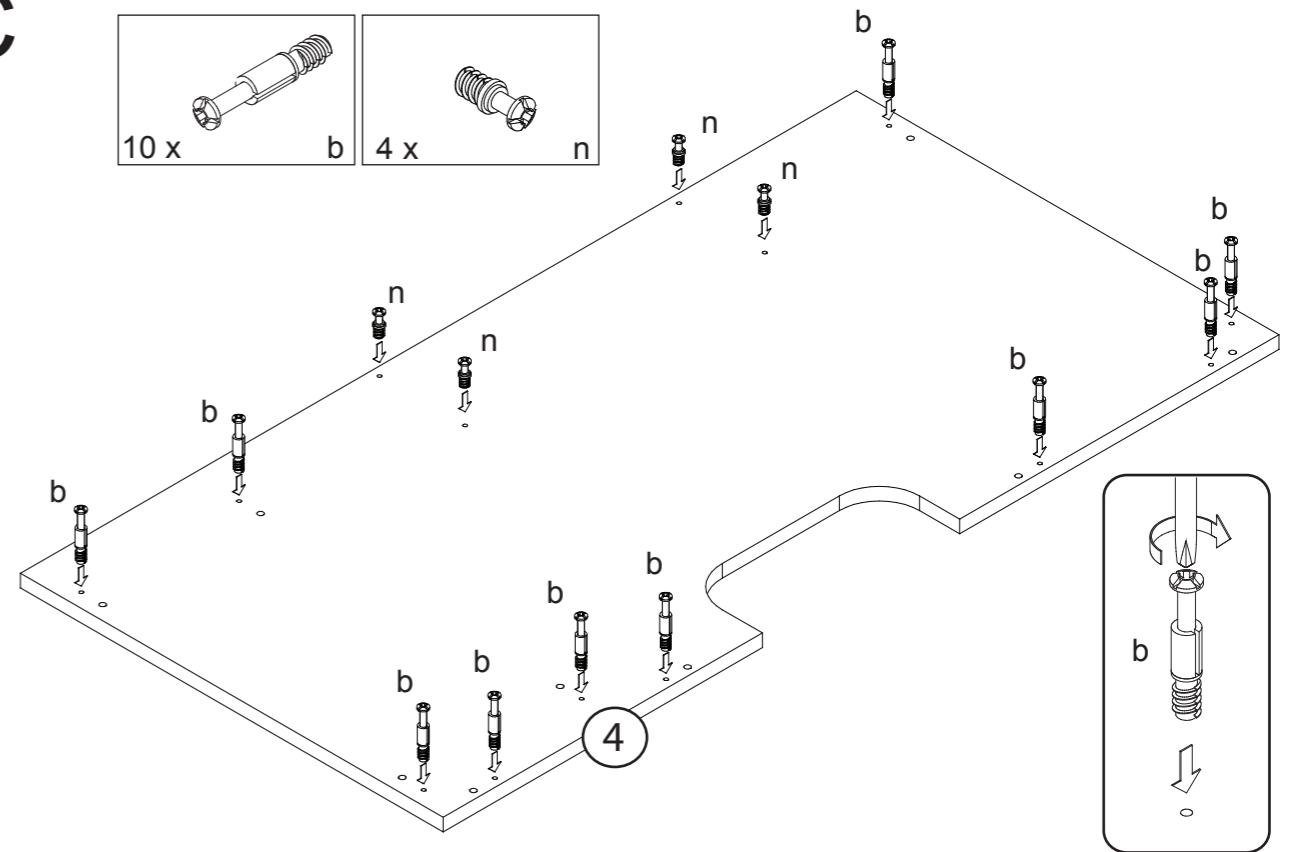

D

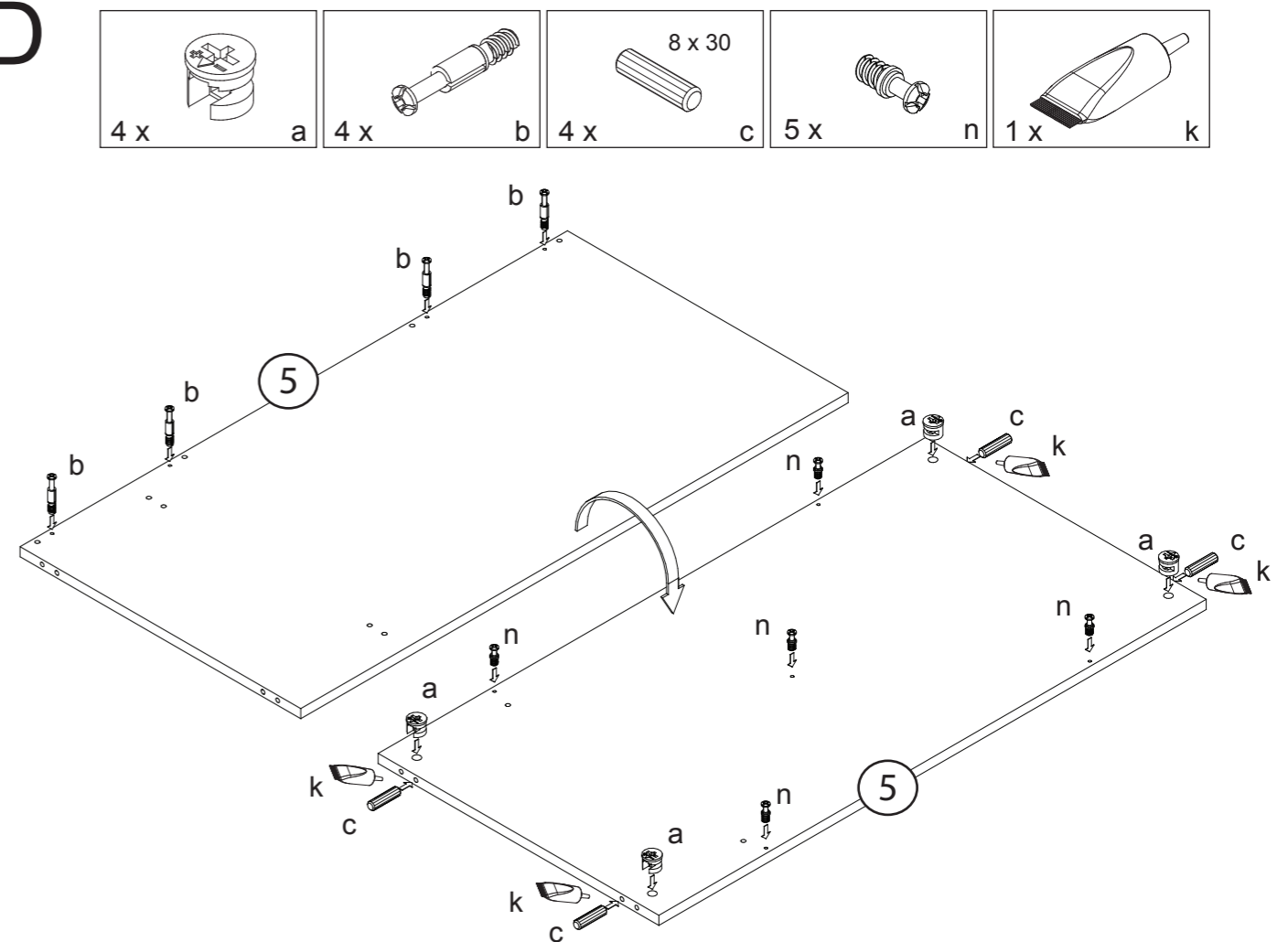

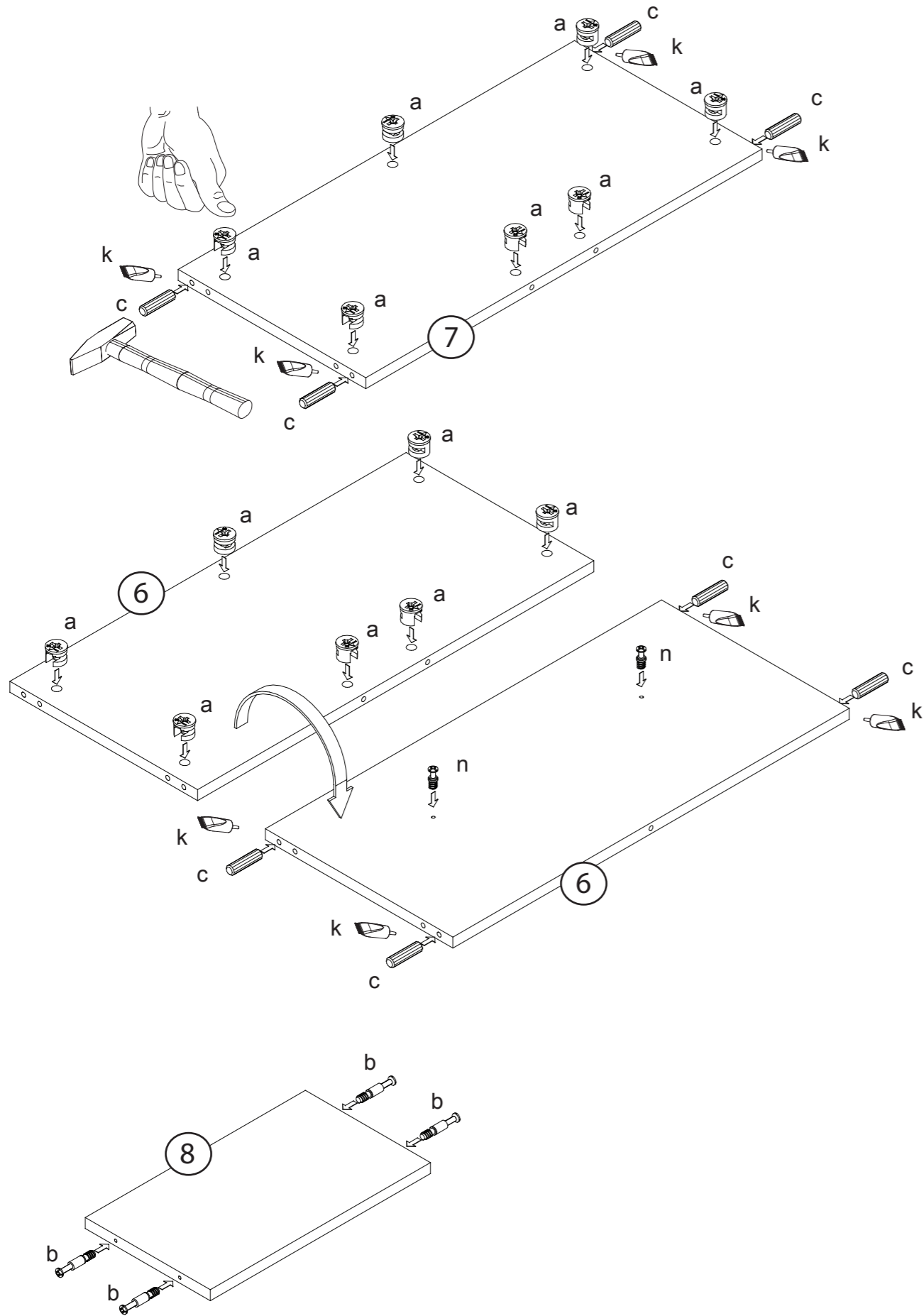
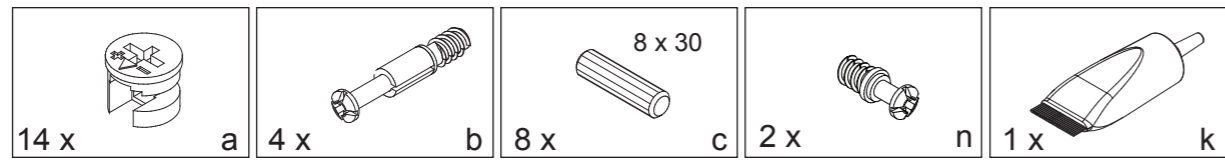
E

6/12

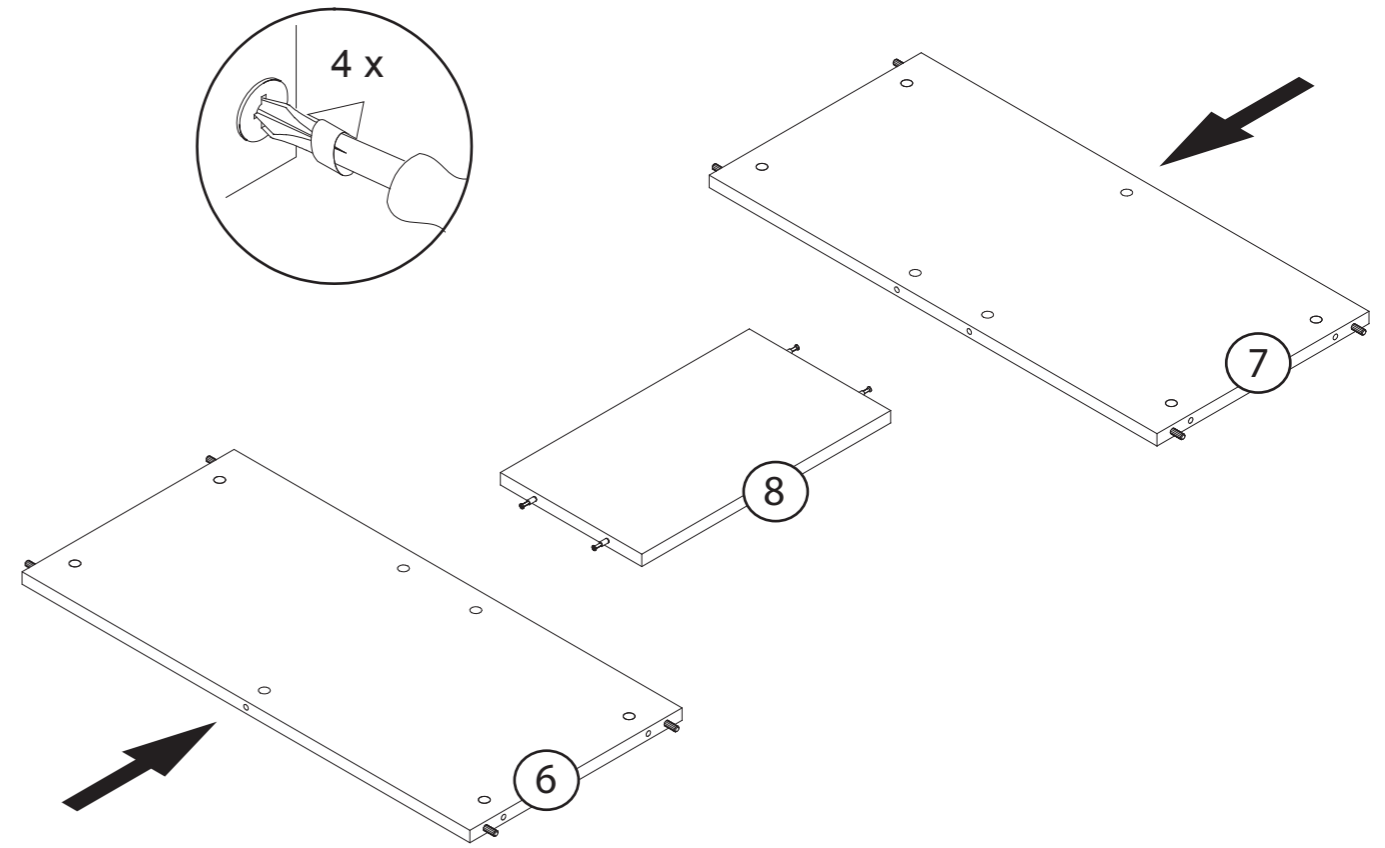
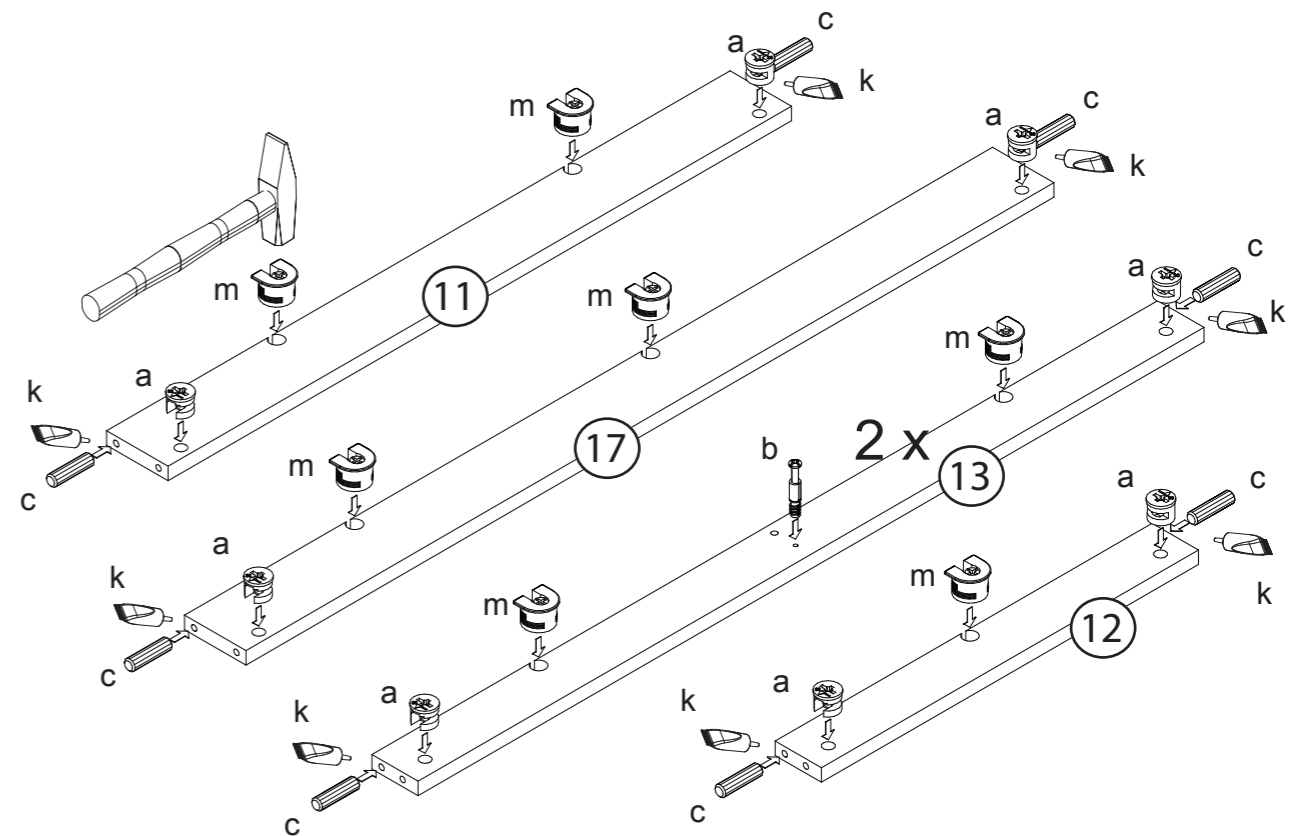
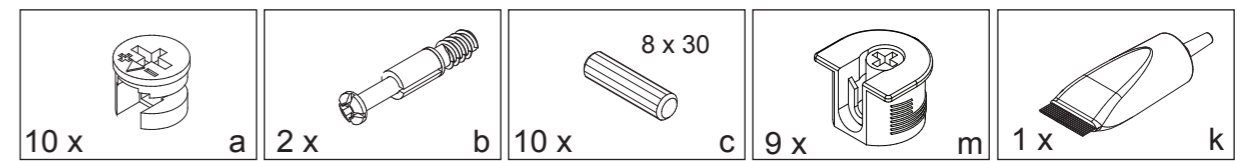
F**G**

7/12